

Paper Dispensers

We surround you in imagination

- Perfectly welded body.
- Back wall construction guaranteeing ventilation between wall and dispenser.
- Robust and vandal resistant.
- The slots in the inside of the body avoid the screws damaging the paper towels.
- A frontal window indicates refill time.
- Maximal convenience, suitable for most common paper types available in the market.
- Maintenance free, easy to keep clean.



14.101

material: AISI 304 stainless steel

finish: satin or bright



14.102

material: AISI 304 stainless steel

finish: satin or bright



14.103

material: AISI 304 stainless steel

finish: satin or bright



COMPONENTS & MATERIALS

- Back has an anti-moisture support.
- A frontal window indicates refill time.
- One-piece body.
- One-piece lid, which can be swung down for replenishment.
- AISI 304 stainless steel axis with inertial anti-spin retainer to optimise the issue of toilet paper. Its diameter allows the use of standard toilet paper if necessary.

TECHNICAL SPECIFICATIONS

14.101

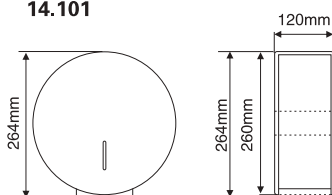

Thickness of body and lid	0.8mm
Weight (empty)	1.24kg
Paper roll capacity	max. Φ 250mm
Toilet roll width	max. Φ 110mm
Toilet roll tube	63mm

14.102

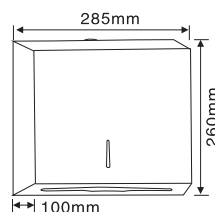

Thickness of body and lid	0.8mm
Weight (empty)	1.67kg
Towels	max.270x100mm

14.103

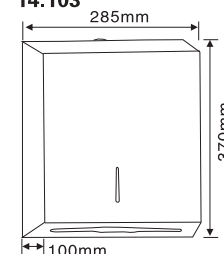

Thickness of body and lid	0.8mm
Weight (empty)	2.2kg
Towels	max.270x100mm



14.201

material: ABS
finish: white



14.202

material: ABS
finish: white



14.203

material: ABS
finish: white

COMPONENTS & MATERIALS

- High-impact ABS.
- One-piece body.
- One-piece lid, which can be swung down for replenishment.
- A frontal window indicates refill time.
- Lock with special keyhole.
- Maintenance free, easy to keep clean.

TECHNICAL SPECIFICATIONS

14.201

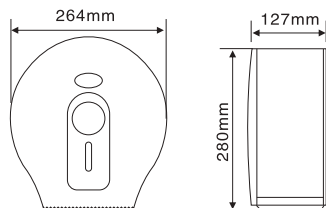

Thickness of body and lid	3mm
Weight (empty)	0.72kg
Paper roll capacity	max. Φ 230mm
Toilet roll width	max. Φ 90mm
Toilet roll tube	70mm

14.202

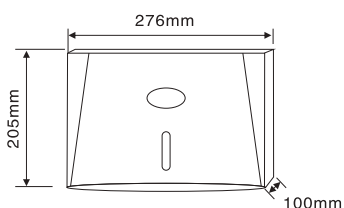

Thickness of body and lid	3mm
Weight (empty)	0.67kg
Towels	max.240x80mm

14.203

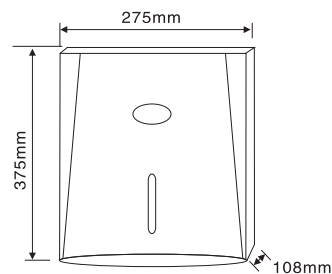

Thickness of body and lid	3mm
Weight (empty)	1.1kg
Towels	max.240x80mm

14.211

material: ABS

finish: white



14.212

material: ABS

finish: white



14.213

material: ABS

finish: white



COMPONENTS & MATERIALS

- High-impact ABS.
- One-piece body.
- Maintenance free, easy to keep clean.
- One-piece lid, which can be swung down for replenishment.
- A frontal window indicates refill time.
- Lock with special keyhole.

TECHNICAL SPECIFICATIONS

14.211

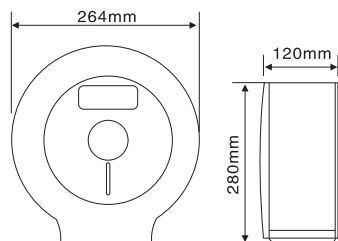

Thickness of body and lid	3mm
Weight (empty)	0.73kg
Paper roll capacity	max. Φ 230mm
Toilet roll width	max. Φ 90mm
Toilet roll tube	70mm

14.212

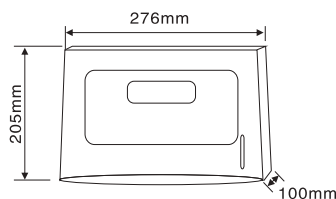

Thickness of body and lid	3mm
Weight (empty)	0.67kg
Towels	max.240x80mm

14.213

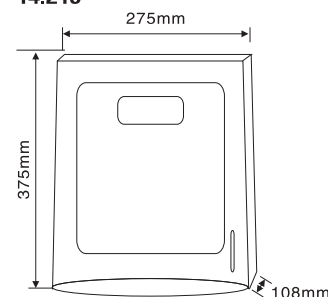

Thickness of body and lid	3mm
Weight (empty)	1.2kg
Towels	max.240x80mm



Two sheets



14.204

material: ABS
finish: white



Two sheets



14.214

material: ABS
finish: white

COMPONENTS & MATERIALS

- High-impact ABS.
- One-piece body.
- One-piece lid, which can be swung down for replenishment.
- A frontal window indicates refill time.
- Lock with special keyhole.
- Maintenance free, easy to keep clean.

TECHNICAL SPECIFICATIONS

14.204

Thickness of body and lid	3mm
Weight (empty)	0.555kg
Toilet roll width	max. Φ 115mm

14.214

Thickness of body and lid	3mm
Weight (empty)	0.550kg
Toilet roll width	max. Φ 115mm

14.204

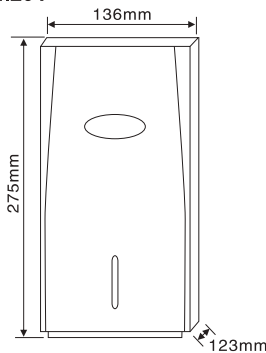

14.214

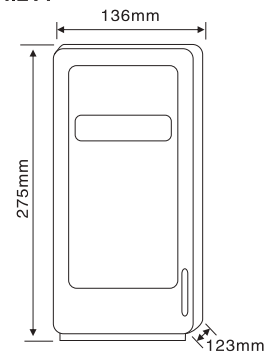

14.205

material: ABS

finish: white

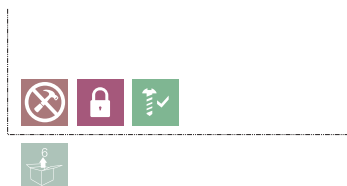

14.215

material: ABS

finish: white

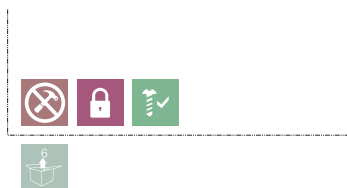

COMPONENTS & MATERIALS

- High-impact ABS.
- One-piece body.
- System for optimizing the issue of paper.
- Lock with special keyhole.
- Maintenance free, easy to keep clean.
- Suitable for food handling establishments.

TECHNICAL SPECIFICATIONS

14.205

Thickness of body and lid	3mm
Weight (empty)	0.980kg
Paper reel	max. Φ 200mm
Height of paper roll	200mm

14.205

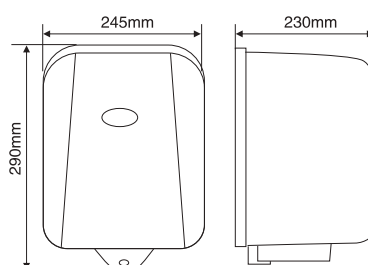

14.215

14.215

Thickness of body and lid	3mm
Weight (empty)	0.848kg
Paper reel	max. Φ 200mm
Height of paper roll	200mm

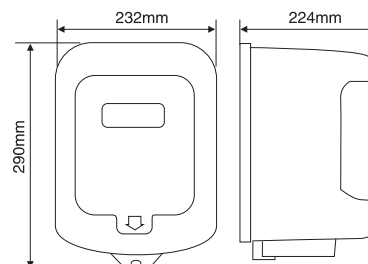



14.206

material: ABS
finish: white



14.216

material: ABS
finish: white

COMPONENTS & MATERIALS

- High-impact ABS.
- One-piece body.
- Easy system for an automatic cut.
- Suitable for food handling establishments.
- Cuts and delivers only one hand towel at a time to a controlled length of 28 cm.
- Lock with special keyhole.
- Maintenance free, easy to keep clean.

TECHNICAL SPECIFICATIONS

14.206

Thickness of body and lid	3mm
Weight (empty)	3.6kg
Towels	200x200 mm

14.216

Thickness of body and lid	3mm
Weight (empty)	3.6kg
Towels	200x200 mm

14.206

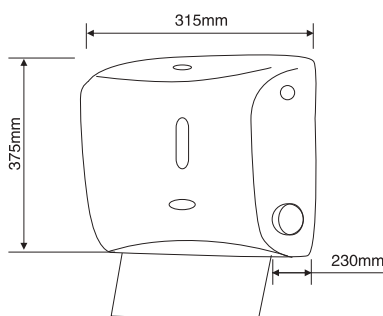

14.216

