

Grab Bars

Give a hand for people with reduced mobility

- Two kinds can be chosen, STEEL and STAINLESS STEEL.
- In all the bars the bending process guarantees the uniformity of the diameter along the bends.
- All the bars are supplied with a snap flange cover to hide the mounting screws, as well as with screws and wall plugs.
- All the steel bars, epoxy finish and polyamide, have been covered with an antioxidant treatment, before final finish.
- Polyamide bars are treated with non-slipping white, that gives the bar a nice feel and a high protection against corrosion and scratches.
- To be installed in all type of washroom which want to be a barrier-free space.
- Some of the models are available in bright finish.
- Ask for price and availability.

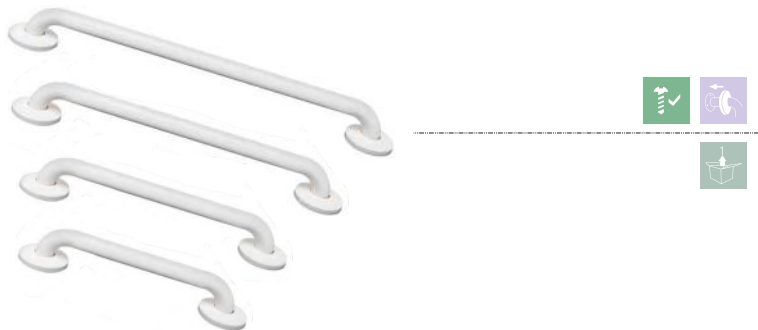



15.101.W

length: 300mm

15.104.W

length: 450mm

15.106.W

length: 600mm

material: steel

finish: white epoxy



15.201.S

length: 300mm

15.202.S

length: 350mm

15.203.S

length: 400mm

15.204.S

length: 450mm

15.205.S

length: 500mm

15.206.S

length: 600mm

15.207.S

length: 700mm

material: AISI 304 stainless steel

finish: satin

COMPONENTS & MATERIALS

- Snap flange cover for hidden mounting.
- Stainless steel nuts and bolts for masonry walls.
- The strength of the bar support will depend on the type of wall and the supports used.

- **15.101.W 15.102.W 15.103.W**
- Tube with anti-rust treatment.

TECHNICAL SPECIFICATIONS

Steel

Bar	Φ 32 mm
Tube thickness	1.2 mm
Snap flange cover	Φ 80 mm

Stainless Steel

Bar	Φ 32 mm
Tube thickness	1.2 mm
Snap flange cover	Φ 78 mm

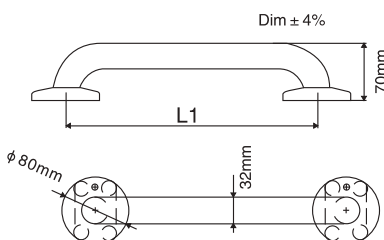

L1

15.101.W	300mm(12")
15.104.W	450mm(18")
15.106.W	600mm(24")

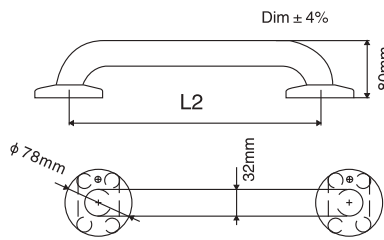

L2

15.201.S	300mm(12")	15.205.S	500mm(20")
15.202.S	350mm(14")	15.206.S	600mm(24")
15.203.S	400mm(16")	15.207.S	760mm(30")
15.204.S	450mm(18")		

Code Length between flanges centres L1,L2

HOTEC | GRAB BARS | angled bars

15.111.W

length: 300x300mm

15.114.W

length: 225x225mm

130° angle

material: steel

finish: white epoxy



15.211.S

length: 300x300mm

15.212.S

length: 350x350mm

15.213.S

length: 400x400mm

130° angle

material: AISI 304 stainless steel

finish: satin

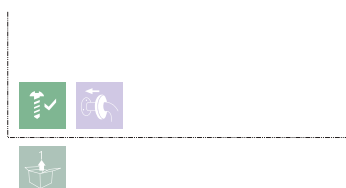

15.211.ST

length: 300x300mm

130° angle

material: AISI 304 stainless steel

finish: satin



COMPONENTS & MATERIALS

- Snap flange cover for hidden mounting.
- Stainless steel nuts and bolts for masonry walls.
- The strength of the bar support will depend on the type of wall and the supports used.

- **15.111.W 15.114.W**
• Tube with anti-rust treatment.
- **15.211.S 15.212.S**
• With 2 anchoring points
- **15.211.ST**
• With 3 anchoring points

TECHNICAL SPECIFICATIONS

15.11X.W

Bar	Φ 32 mm
Tube thickness	1.2 mm
Snap flange cover	Φ 80 mm

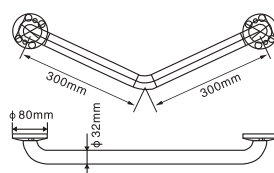

15.111.W 300x300mm
15.114.W 225x225mm

15.21X.S

Bar	Φ 32 mm
Tube thickness	1.2 mm
Snap flange cover	Φ 78 mm

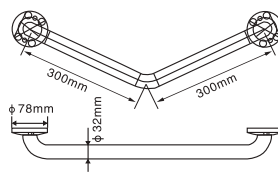

15.211.S 300x300mm
15.212.S 350x350mm
15.213.S 400x400mm

15.211.ST

Bar	Φ 32 mm
Tube thickness	1.2 mm
Snap flange cover	Φ 78 mm

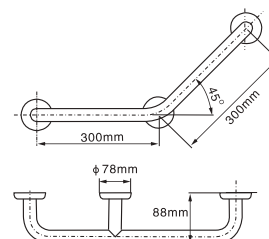

15.211.ST 300x300mm



15.121.W
 length: 600mm
 material: steel
 finish: white epoxy



15.221.S
 length: 600mm
15.222.S
 length: 700mm
15.223.S
 length: 800mm
 material: AISI 304 stainless steel
 finish: satin

COMPONENTS & MATERIALS

- Safety system that blocks the bar in a vertical position to prevent it dropping accidentally.
- Stainless steel nuts and bolts for masonry walls.
- The strength of the bar support will depend on the type of wall and the supports used.
- Toilet roll holder hook.
- 15.121W**
- Tube with anti-rust treatment.

TECHNICAL SPECIFICATIONS

Bar	Ø 32 mm
Tube thickness	1.2 mm

Steel

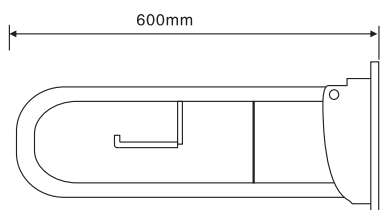

15.121.W 600mm

Stainless Steel

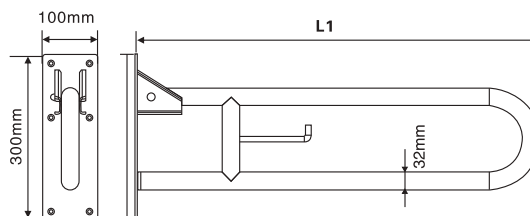

L1	15.221.S	600mm
	15.222.S	700mm
	15.223.S	800mm

HOTEC | GRAB BARS | swing up bars

15.224.S

material: AISI 304 stainless steel
finish: satin

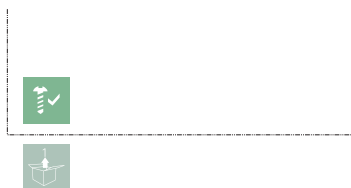

15.225.S

material: AISI 304 stainless steel
finish: satin

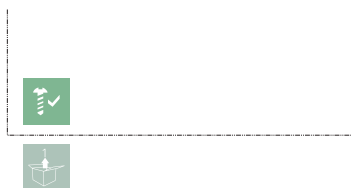

COMPONENTS & MATERIALS

- Safety system that blocks the bar in a vertical position to prevent it dropping accidentally.
- Stainless steel nuts and bolts for masonry walls.
- The strength of the bar support will depend on the type of wall and the supports used.

15.224.S

- Toilet roll holder hook.

15.225.S

- Opening system that transfers the support to the floor on the bar downwards.

TECHNICAL SPECIFICATIONS

Bar	Φ 32 mm
Tube thickness	1.2 mm

15.224.S

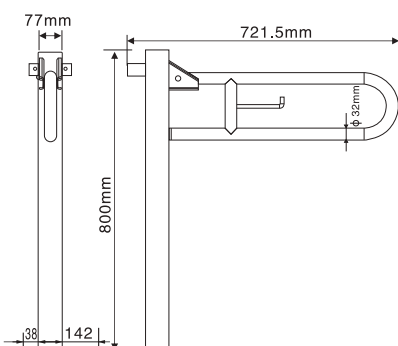

15.225.S

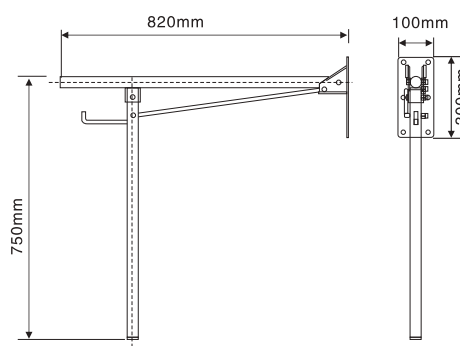



15.231.S
15.232.S

material: AISI 304 stainless steel
finish: satin



15.233.S

material: AISI 304 stainless steel
finish: satin



15.241.S 600mm
15.242.S 700mm
90° angled
15.243.S 600mm
15.244.S 700mm
90° angled

material: AISI 304 stainless steel
finish: satin



15.251.S 600mm
15.252.S 800mm

material: AISI 304 stainless steel
finish: satin

COMPONENTS & MATERIALS

- Stainless steel nuts and bolts for masonry walls.
- Snap flange cover for hidden mounting.
- The strength of the bar support will depend on the type of wall and the supports used.

TECHNICAL SPECIFICATIONS

Bar	Φ 32 mm
Tube thickness	1.2 mm
Snap flange cover	Φ 78 mm

15.231.S 15.232.S

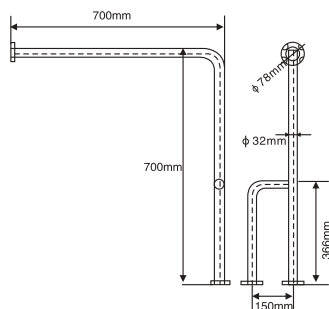

15.233.S

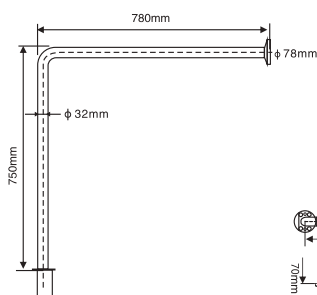

15.24x.S

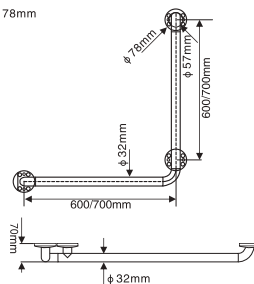

15.25x.S

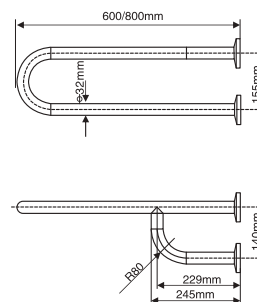

15.301

material: ABS/aluminum
 finish: white
 bearing weight: max. 150kg



15.302

material: ABS/aluminum/stainless steel
 finish: white
 bearing weight: max. 180kg

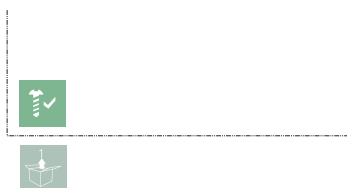

15.311

material: solid wood/aluminum
 finish: natural/white/chrome
 bearing weight: max. 150kg



15.312

material: solid wood/stainless steel
 finish: natural/bright
 bearing weight: max. 180kg

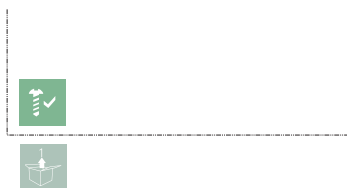

COMPONENTS & MATERIALS

- Easy to install.
- Waterproof.
- Fixings for masonry walls and installation instructions are included.
- Main body thickness 3 cm

15.302

- White powder coating on bracket and legs.

15.301 15.311

- Aluminum wall-mount bracket.
- Aluminum bracket with independent installation panel.

15.312

- Polished stainless steel bracket and legs.

TECHNICAL SPECIFICATIONS

15.301

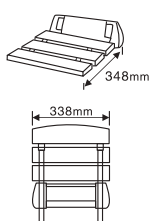

15.302

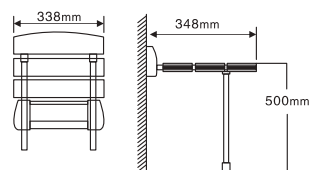

15.311

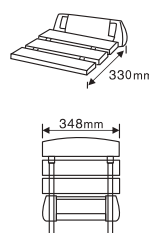

15.312

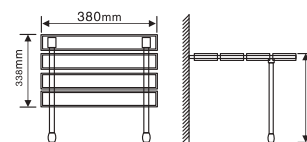



15.401

material: ABS/aluminum/HDPE
finish: white



15.403

material: ABS/aluminum/HDPE
finish: white

COMPONENTS & MATERIALS

- Shower Chair with Handle and Back Rest. HDPE body with aluminum legs. • 15.403 without handle.
- Fully height adjustable.
- Ergonomic handles for support when standing.
- Ferruled feet provide stability on a wet floor. Non-slip seat surface.
- Aluminium handle and legs. Lightweight aluminium frame.
- Easy, tool-free assembly. Smooth, accessible surfaces for ease of cleaning.
- Highest durability and rusting resistance.
- Waterproof. Suitable for accesible toilets, wc, showers and baths. It normally goes along with a grab bar.

TECHNICAL SPECIFICATIONS

Bearing weight: 135 kgs
Height adjustable: 38 to 50 cm (From floor to seat)

15.401
Weight of shower chair: 3.2 kg

15.403
Weight of shower chair: 2.8 kg

15.401

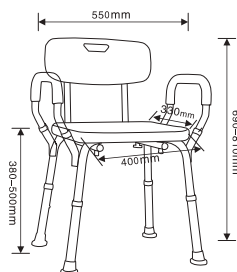

15.403

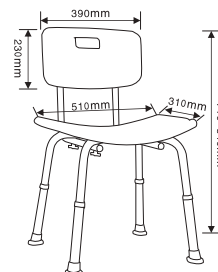

HOTEC | GRAB BARS | Shower chair

15.404

material: ABS/aluminum/HDPE
finish: white

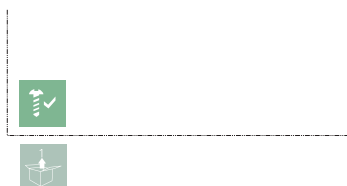

15.405

material: ABS/aluminum/HDPE
finish: white



COMPONENTS & MATERIALS

- **15.404.** Shower Chair, HDPE body with aluminum legs.
- Ergonomic hand grips at the sides of the seat for maximum comfort.
- **15.405.** Round Shower Stool, HDPE body with aluminum legs.
- It is ideal for people that are unable to stand for extended periods.
- Ferruled feet provide stability on a wet floor. Non-slip seat surface.
- Easy, tool-free assembly. Smooth, accessible surfaces for ease of cleaning.
- Waterproof. Suitable for accessible toilets, wc, showers and baths. It normally goes along with a grab bar.
- Fully height adjustable.
- Sturdy and lightweight aluminium frame.
- Highest durability and rusting resistance.

TECHNICAL SPECIFICATIONS

Bearing weight: 135 kgs

15.404

Weight of shower chair: 2.05 kg

15.405

Weight of shower chair: 1.5 kg

15.404

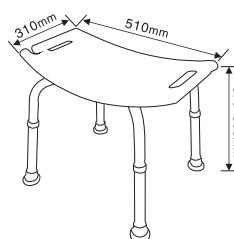

15.405

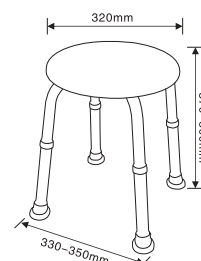



15.501

material: ABS/stainless steel

finish: white

bearing weight: max.130kg



15.502

material: ABS/stainless steel

finish: white

bearing weight: max.130kg

COMPONENTS & MATERIALS

- Easy to install.
- Waterproof.
- White seat: Polished stainless steel bracket. The length of bracket can be adjusted to fit for tubs in different size.
- Main body thickness 3 cm

TECHNICAL SPECIFICATIONS

15.501

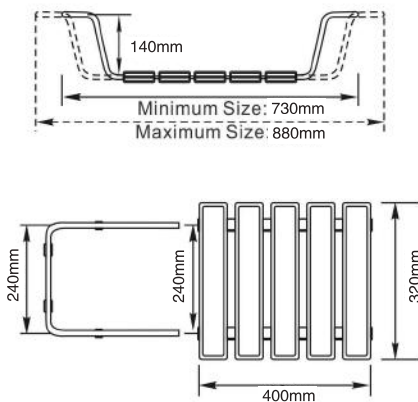

15.502

